

LC1M VM

Valvole modulari limitatrici di pressione
Modular pressure relief valves

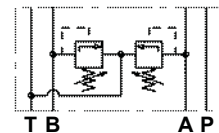

CARATTERISTICHE TECNICHE

Grandezza: NG6 ISO 4401 - 03 CETOP RP121 H-03 (CETOP 3)

Portata massima: 50 l/min

Pressione massima d'esercizio: 310 bar

TECHNICAL CHARACTERISTICS

Size: NG6 ISO 4401 - 03 CETOP RP121 H-03 (CETOP 3)

Max flow: 50 l/min

Max operating pressure: 310 bar



TIPI DI VALVOLE • VALVES TYPES

01AB

010A

010B

02AB

020A

020B

010P

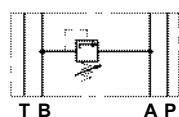
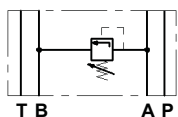
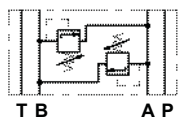
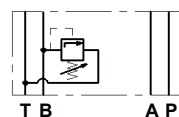
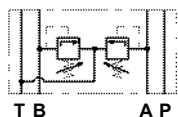

CARATTERISTICHE TECNICHE • TECHNICAL FEATURES

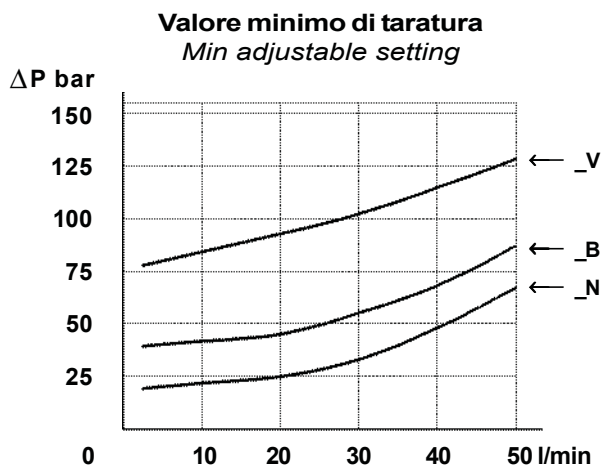
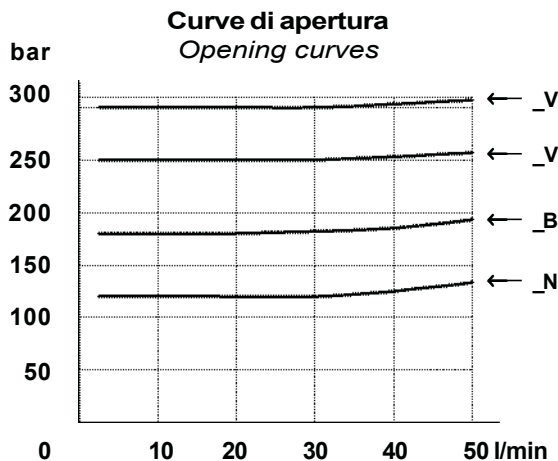

GRANDEZZA • SIZE : NG6 ISO 4401-03 CETOP RP 121 H03 (CETOP 3)

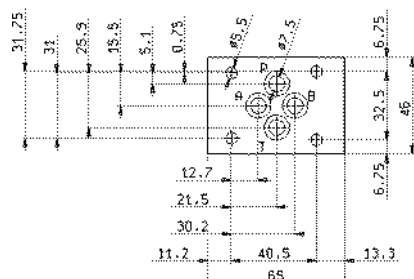

Qualità superficie di attacco

Mounting plane quality

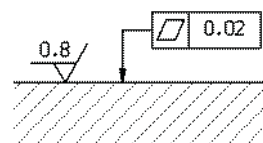

DIMENSIONI DI INGOMBRO • OVER-ALL DIMENSIONS

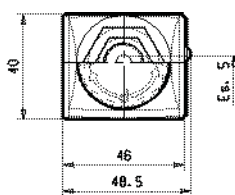
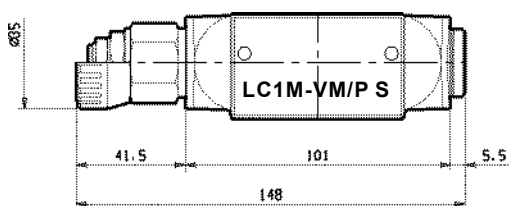

K = Valvola con taratura a volantino
Knob adjustment

S = Valvola con taratura a chiave
Screw adjustment

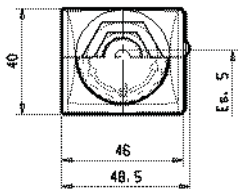
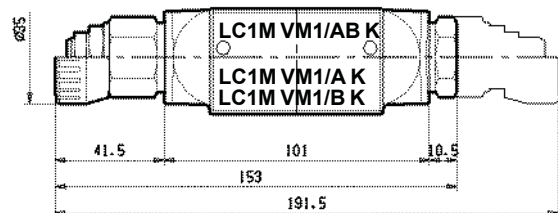
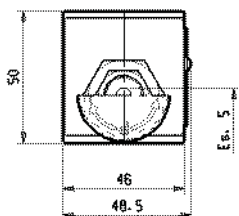
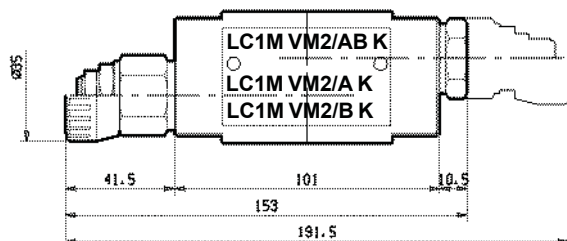

Peso

Weight

LC1M VM1/AB	1.28 kg
LC1M VM1/A	1.20 kg
LC1M VM1/B	1.20 kg
LC1M VM2/AB	1.67 kg
LC1M VM2/A	1.59 kg
LC1M VM2/B	1.59 kg
LC1M VM/P	1.25 kg



VALVOLA LIMITATRICE DI PRESSIONE A CARTUCCIA • RELIEF VALVE CARTRIDGE

Tipo **K** = Valvola con regolazione a volantino
Type **K** = Knob adjustment

Tipo **S** = Valvola con regolazione a chiave
Type **S** = Screw adjustment

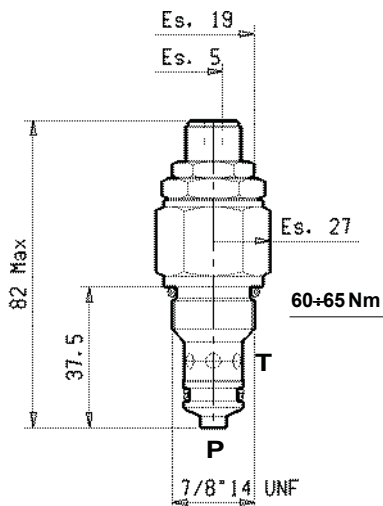
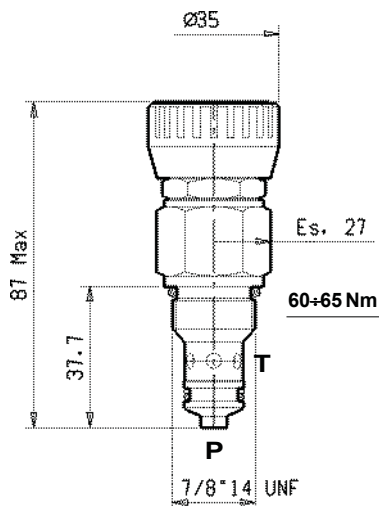

Con limitatore di corsa antischacciamento molla.
With stroke limiter to avoid spring exclusion.

Tipo Type	X		Portata Max. Max. flow l/min	Pressione Max. Max. pressure bar	Campo di taratura Pressure range bar	Cavità Cavity n°	Peso Weight kg
	Regolazione a volantino Knob adjustment	Regolazione a vite Screw adjustment					
VMD1 040	KN	SN	50	350	20÷130	C10A2N	0,20
	KB	SB			40÷180		
	KV	SV			80÷350		
00		Senza valvola limitatrice - Without pressure relief valve					

CODICE DI ORDINAZIONE • ORDERING CODE

L 6 1 6 1 **V** **W** **X** 0 0 **Z**

V	MODELLO MODEL
01	MODELLO 01 (scarico in T) MODEL 01 (T outlet)
02	MODELLO 02 (scarico incrociato) MODEL 02 (cross-over outlet)

W	TIPI DI VALVOLE VALVES TYPE
AB	LC1M-VM_/AB
0A	LC1M-VM_/A
0B	LC1M-VM_/B
0P	LC1M-VM_/P

X	CAMPO DI TARATURA PRESSURE RANGE
--	VEDI SOPRA SEE ABOVE

Z	VERSIONE VERSION
00	STANDARD STANDARD
0V	GUARNIZIONI IN VITON SEALS IN VITON