

This booklet is meant to be a technical deepening on the **BC60** directional control valve. Choice, use, maintenance and warranty conditions of all products are described in the General Catalog.

The **BC60** sectional valve has been designed for the remote proportional actuation of systems with fix displacement pumps. However, the installation of an auxiliary electro-valve (**LSK**) allows the utilization of the **BC60** valve in systems with variable displacement pumps (**LS**).

The actuation of the **BC60** valve can be electric proportional (**HE**), hydraulic proportional (**HO**) or the combination of the two.

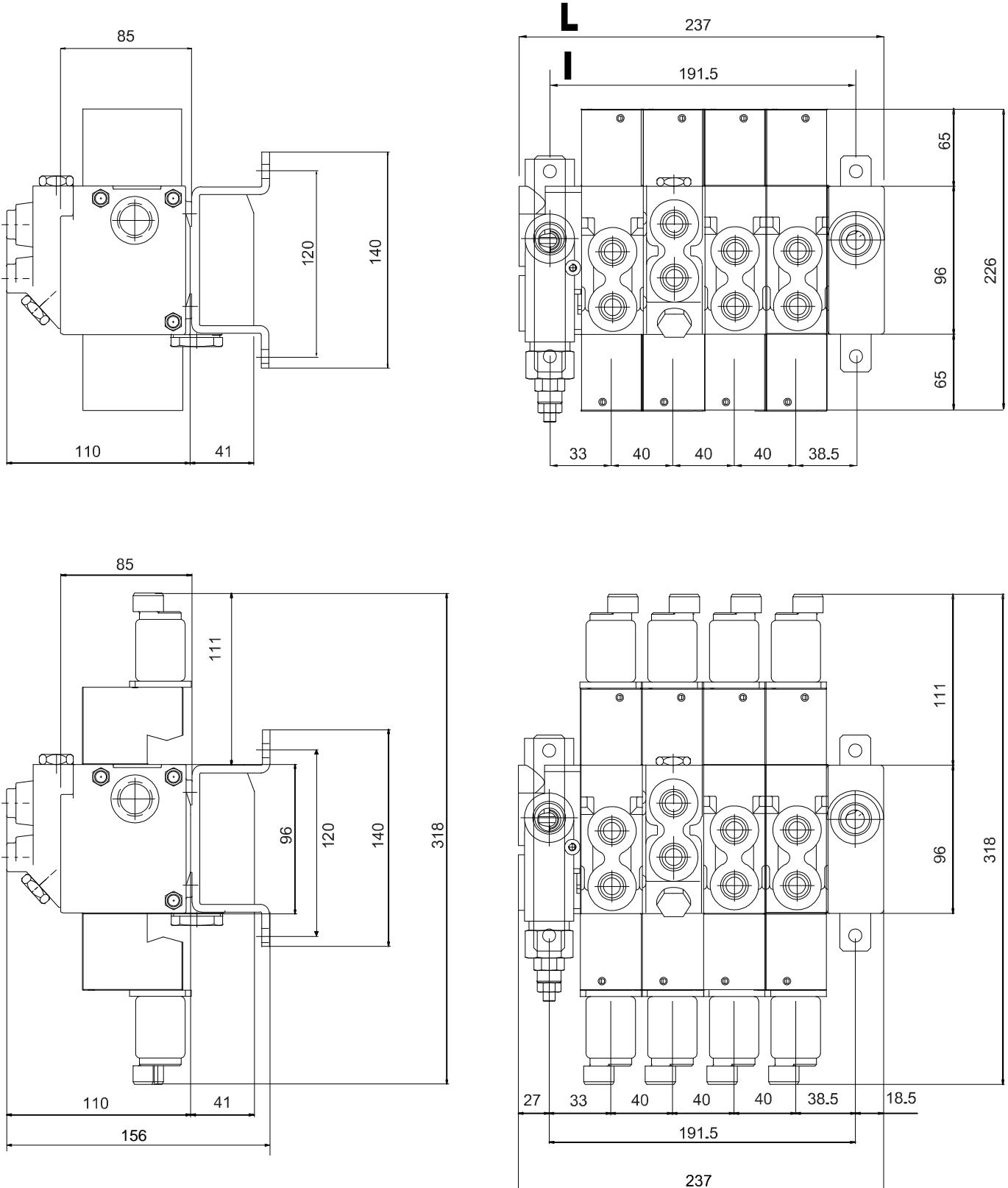

TECHNICAL CHARACTERISTICS		
NOMINAL FLOW	60 l/min	16 GPM
MAX FLOW	70 l/min	18 GPM
NOMINAL PRESSURE	300 bar	3600 PSI
MAX PRESSURE ON PORTS	320 bar	4700 PSI
MAX PRESSURE ON TANK-LINE	15 bar	220 PSI
MAX SERVO PRESSURE SETTING	30 bar	440 PSI

INTERNAL OIL LEAKAGE	
From A B to T	4 ÷ 8 cc/min
TESTING CONDITIONS	
Pressure	100 bar
Oil temperature	40 °C
Oil viscosity	32 mm ² /s

STANDARD THREADS					
	A - B	P	T	P2	T2
G (BSP)	1/2"	1/2"	1/2"	1/2"	1/2"
F (UNF)	7/8"-14	7/8 -14	7/8"-14	7/8"-14	7/8"-14

NUMBER OF SECTIONS	L		I	
	(mm)	(inch)	(mm)	(inch)
BC60/1	117	4,6	71,5	2,81
BC60/2	157	6,18	111,5	4,54
BC60/3	197	7,75	151,5	5,96
BC60/4	237	9,33	191,5	7,53
...

ACTUATORS

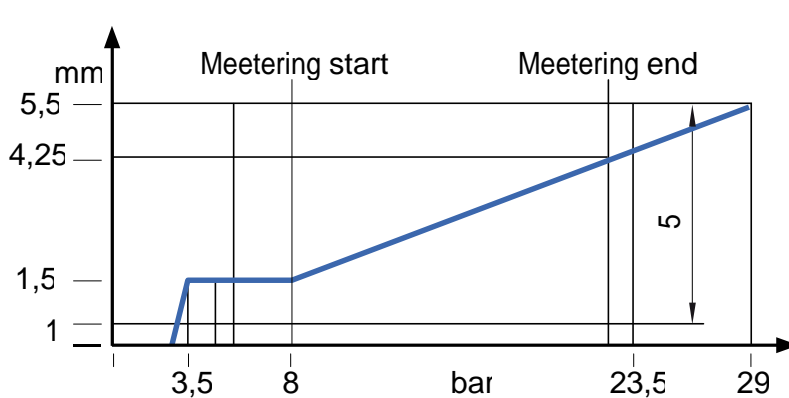
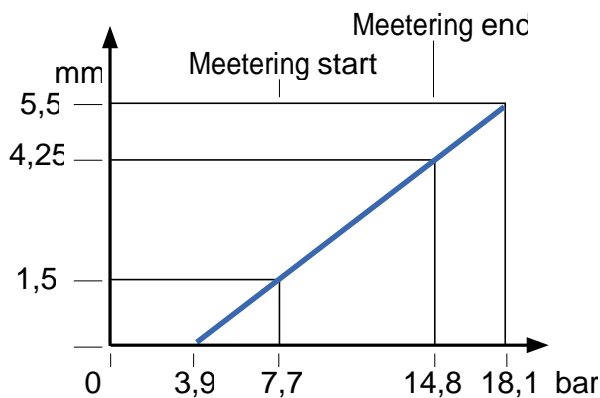

SPOOL TYPES

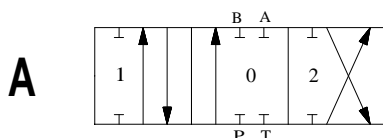

4-WAY / 3-POSITION SPOOL. Provides control of double-acting cylinders or bi-directional hydraulic motors. In position 0 work ports are blocked.

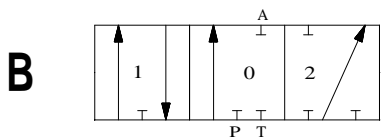

3-WAY / 3-POSITION SPOOL. Provides control of single-acting cylinders or start and stop of uni-directional hydraulic motors. In position 0 work port is blocked. B port is plugged.

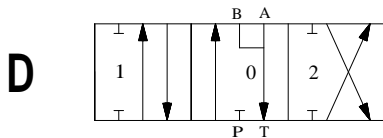

4-WAY / 3-POSITION SPOOL, OPEN CENTER (MOTOR SPOOL). Provides control of double acting cylinders or bi-directional hydraulic motors. Allows a cylinder to float or a motor to wheel free when the spool is in position 0. Work ports are open to the tank port when the spool is in position 0.

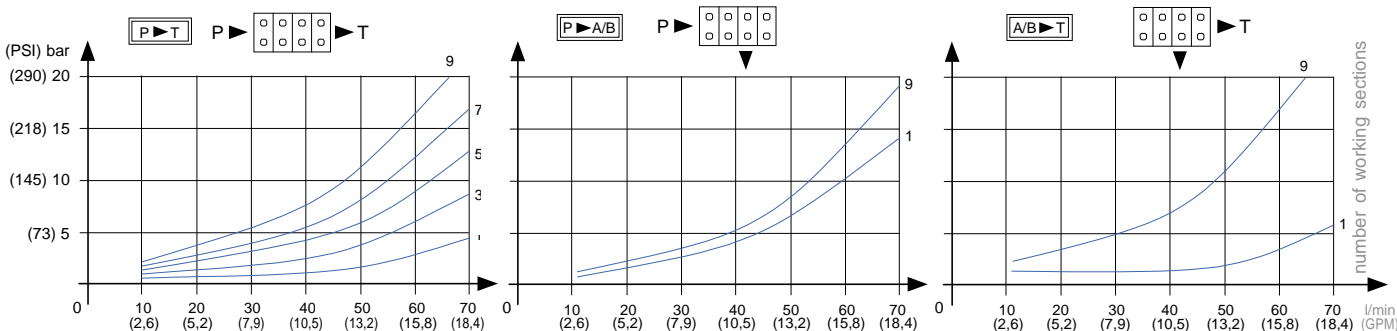

The **BC60** sectional valve has the following features:

- Possibility to have auxiliary valves on ports: antishock valves (**VL**), anticavitation valves (**VC**) and combined antishock and anticavitation valves (**VLC**);
- Check valves on each section;
- Priority flow control sections (**RFS**, **RFP**)
- Elements with integrated pressure compensated flow control (**CF**, **FCV**).

Thanks to its high versatility and modular structure, the **BC60** valve can be used in simple and complex hydraulic systems, fulfilling the most advanced requirements of the modern mobile machines.

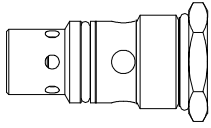

VC

ANTICAVITATION VALVE

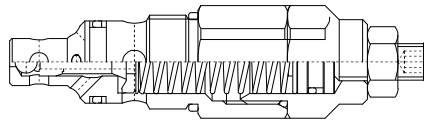

VLC

COMBINED ANTISHOCK AND ANTICAVITATION VALVE

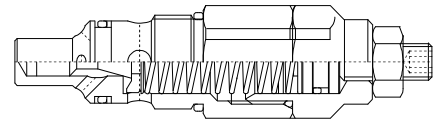

VL

ANTISHOCK VALVE

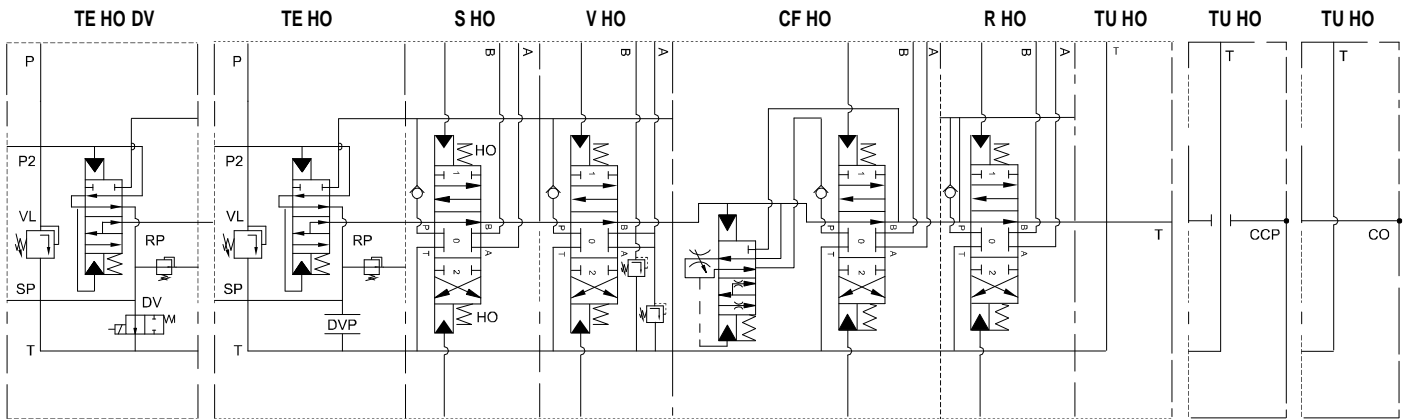

INLET WITH DUMP VALVE

STANDARD INLET

STANDARD ELEMENT

ELEMENT ACCEPTING VALVES ON PORTS

FLOW CONTROL ELEMENT

RECUPERATION ELEMENT

STANDARD OUTLET OPEN CENTER

STANDARD OUTLET WITH CLOSE CENTER PLUG

STANDARD OUTLET WITH CARRY OVER ADAPTOR

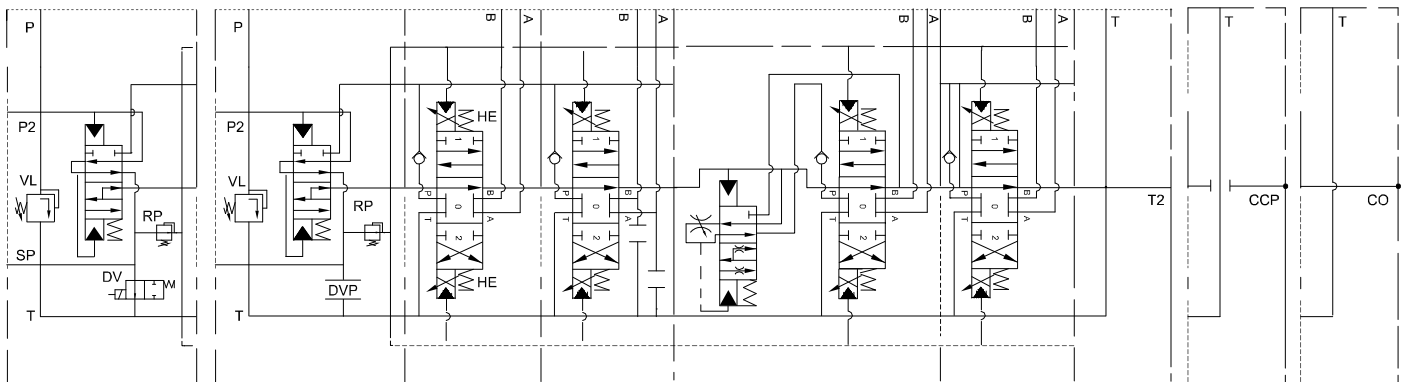

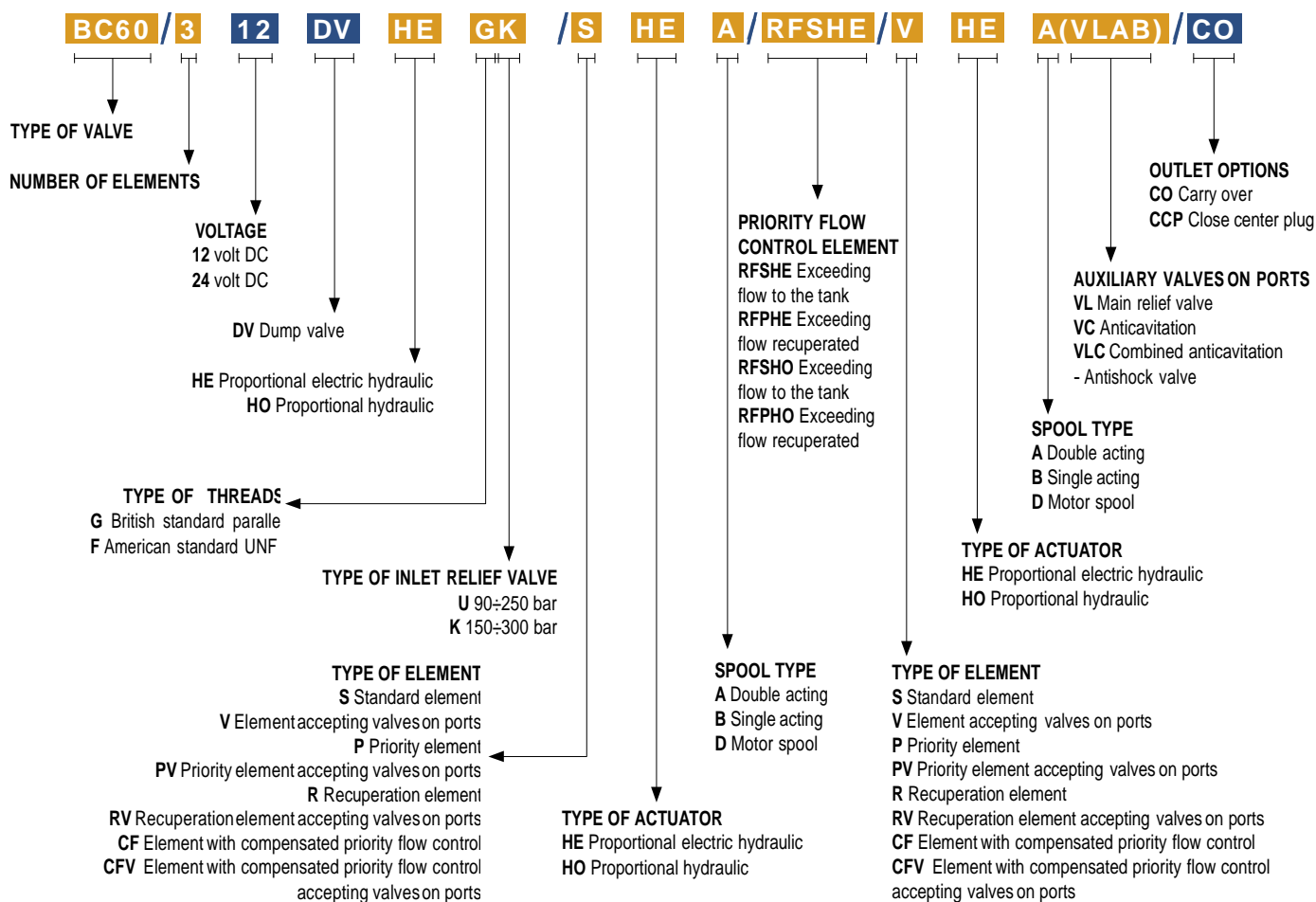
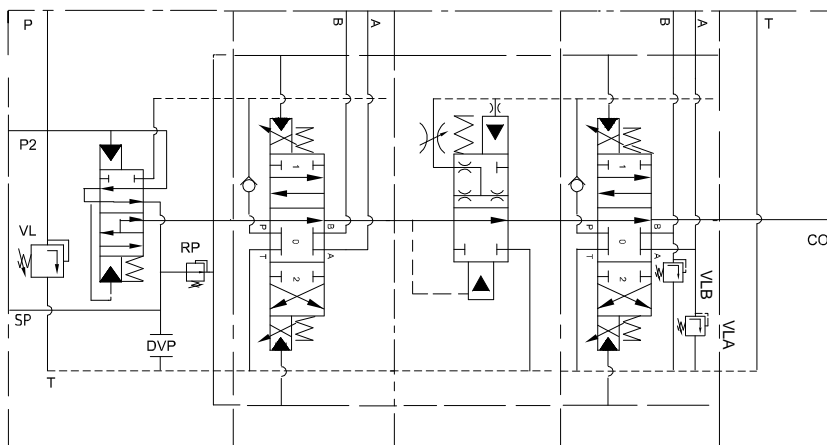

LEGEND

- | | | | | |
|--|---|---|--|--|
| <p>A Port</p> <p>B Port</p> <p>P Pump connection</p> <p>P2 Pump connection</p> <p>SP Servo pressure</p> | <p>RP Pressure reducing valve</p> <p>RVP Relief valve plug</p> <p>DV Dump valve</p> <p>DVP Dump valve plug</p> <p>VL Main relief valve</p> | <p>VLAB Antishock valves</p> <p>VLC Antishock and anticavitation valve</p> <p>VC Anticavitation valve</p> <p>HO Hydraulic proportional actuator</p> <p>HE Electric proportional actuator</p> | <p>T Tank connection</p> <p>T2 Tank connection</p> <p>CCP Close center plug</p> <p>CO Carry over</p> | <p> MANDATORY FIELD</p> <p> OPTIONAL FIELD</p> |
|--|---|---|--|--|

INLET



TE HE

2 kg

TE HE inlet elements feature a pressure compensated flow divider and a pressure reducing valve (RP) set at 25/30 bar. These two devices are used to generate an auxiliary pressure, needed to operate the spools through electric or hydraulic proportional actuators. The auxiliary pressure can be taken out of the inlet and connected to other users.

BC60TE HE GU	805143
BC60TE HE GK	805019
BC60TE HE FU	805145
BC60TE HE FK	805111

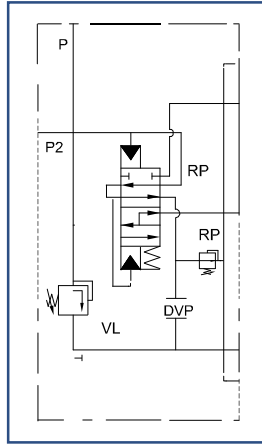

INLET WITH DUMP VALVE



TE HE DV

2,3 kg

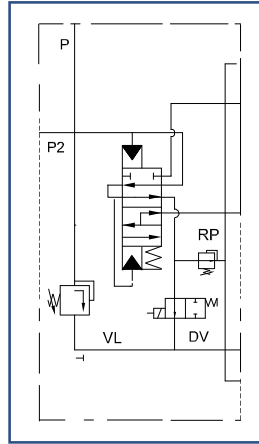

BC60TE 12 HE DV GU	805147
BC60TE 12 HE DV GK	805148
BC60TE 12 HE DV FU	805150
BC60TE 12 HE DV FK	805151
BC60TE 24 HE DV GU	805153
BC60TE 24 HE DV GK	805126
BC60TE 24 HE DV FU	805155
BC60TE 24 HE DV FK	805129

DV dump valve prevents the unwanted or accidental use of the directional control valve, connecting the auxiliary pressure to tank.

OUTLET



TU HE

1,7 kg

BC60TU HE G	805091
BC60TU HE F	805114

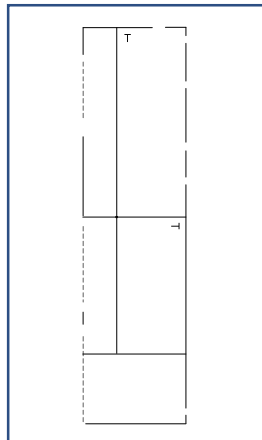

OUTLET WITH ANTISHOCK VALVE VL



TU HE VL

1,9 kg

BC60TU HEVL G	805137
BC60TU HEVL F	805138

The **VL** valve preserves the system from accidental pressure peaks in the tank line. **VL** setting is 100 bar.

STANDARD ELEMENT

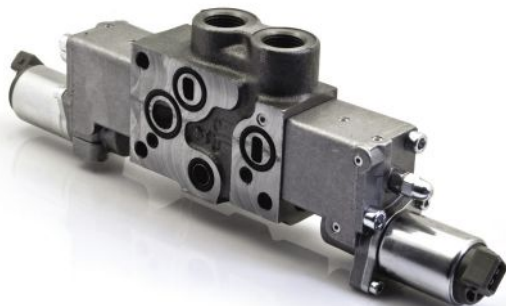

S HE

2,7 kg

STANDARD ELEMENT
ACCEPTING
VALVES
ON PORTS



V HE

3,3 kg

BC60S 12 G /HE A/	807597
BC60S 24 G /HE A/	807594
BC60S 12 F /HE A/	807655
BC60S 24 F /HE A/	807656

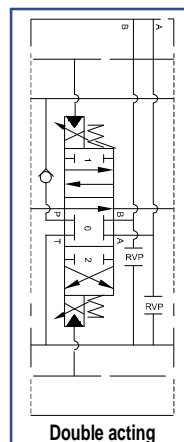
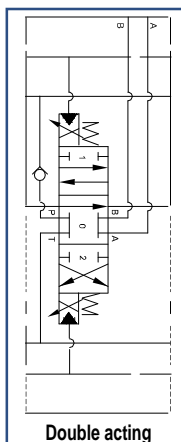

BC60V 12 G /HE A RVPAB/	807661
BC60V 24 G /HE A RVPAB/	807595
BC60V 12 F /HE A RVPAB/	807662
BC60V 24 F /HE A RVPAB/	807663

BC60V 12 G /HE A VLAB/	807840
BC60V 24 G /HE A VLAB/	807596
BC60V 12 F /HE A VLAB/	807841
BC60V 24 F /HE A VLAB/	807842

VL valves on ports **A** and **B** are type **U**.
Standard setting 140 bar.

BC60S 12 G /HE B/	807651
BC60S 24 G /HE B/	807653
BC60S 12 F /HE B/	807657
BC60S 24 F /HE B/	807658

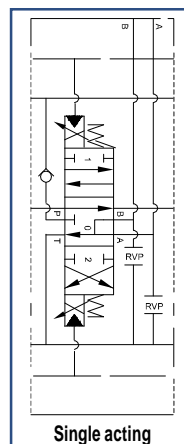
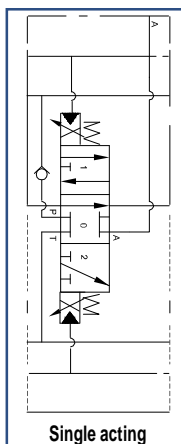

BC60V 12 G /HE B RVPAB/	807664
BC60V 24 G /HE B RVPAB/	807665
BC60V 12 F /HE B RVPAB/	807666
BC60V 24 F /HE B RVPAB/	807667

BC60V HE 12 G B VLAB/	807843
BC60V HE 24 G B VLAB/	807844
BC60V HE 12 F B VLAB/	807845
BC60V HE 24 F B VLAB/	807846

VL valves on ports **A** and **B** are type **U**.
Standard setting 140 bar.

BC60S 12 G /HE D/	807652
BC60S 24 G /HE D/	807654
BC60S 12 F /HE D/	807659
BC60S 24 F /HE D/	807660

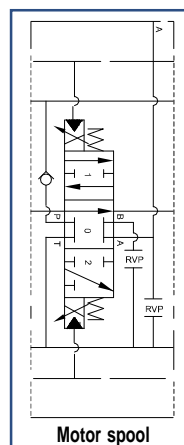
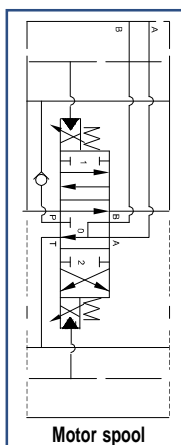

BC60V 12 G /HE D RVPAB/	807668
BC60V 24 G /HE D RVPAB/	807669
BC60V 12 F /HE D RVPAB/	807670
BC60V 24 F /HE D RVPAB/	807671

BC60V 12 G /HE D VLAB/	807847
BC60V 24 G /HE D VLAB/	807848
BC60V 12 F /HE D VLAB/	807849
BC60V 24 F /HE D VLAB/	807850

VL valves on ports **A** and **B** are type **U**.
Standard setting 140 bar.

FLOW CONTROL ELEMENT

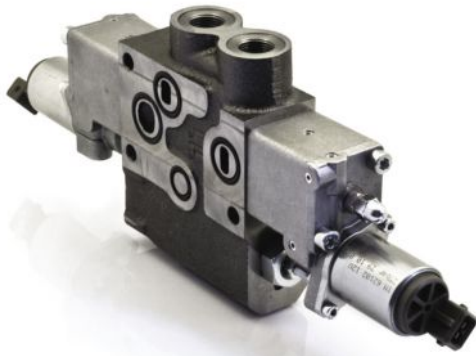

CF HE

kg 3,9

FLOW CONTROL ELEMENT ACCEPTING VALVES ON PORTS

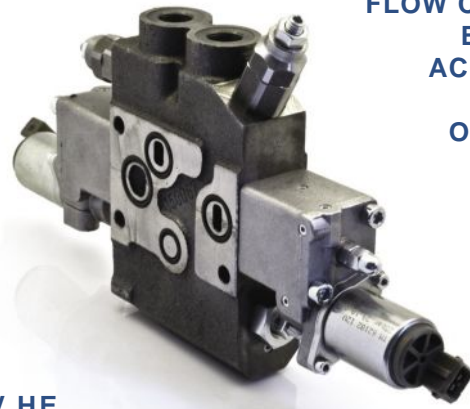

CFV HE

kg 4,5

CF and CFV elements integrate a pressure compensated flow control that allows the external regulation of the flow inside the elements themselves and recuperates the exceeding flow (EF) for the following elements.

BC60CF 12 G /HE A/	807718
BC60CF 24 G /HE A/	807719
BC60CF 12 F /HE A/	807720
BC60CF 24 F /HE A/	807721

BC60CF 12 G /HE B/	807722
BC60CF 24 G /HE B/	807723
BC60CF 12 F /HE B/	807724
BC60CF 24 F /HE B/	807725

BC60CF 12 G /HE D/	807726
BC60CF 24 G /HE D/	807727
BC60CF 12 F /HE D/	807728
BC60CF 24 F /HE D/	807729

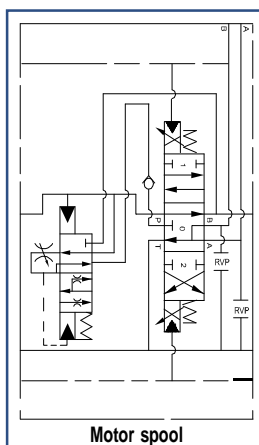
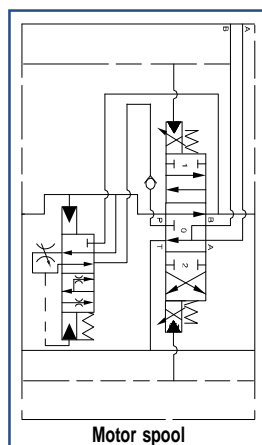
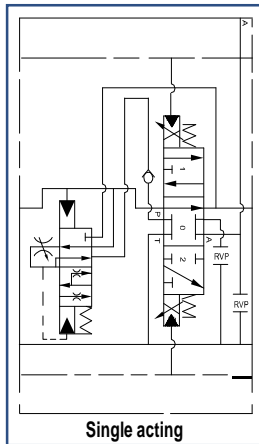
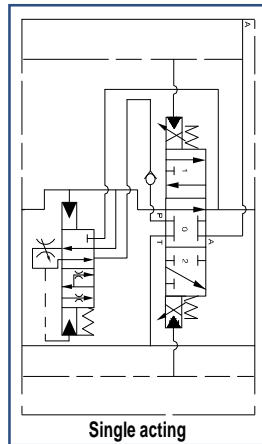
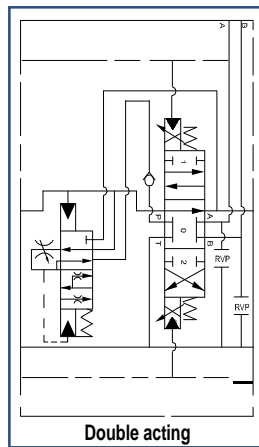
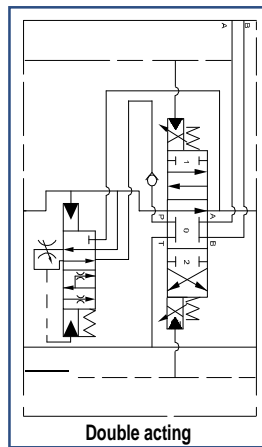

BC60CFV 12 G /HE A RVPAB/	807730
BC60CFV 24 G /HE A RVPAB/	807731
BC60CFV 12 F /HE A RVPAB/	807732
BC60CFV 24 F /HE A RVPAB/	807733

BC60CFV 12 G /HE A VLAB/	807851
BC60CFV 24 G /HE A VLAB/	807852
BC60CFV 12 F /HE A VLAB/	807853
BC60CFV 24 F /HE A VLAB/	807854

VL valves on ports A and B are type U. Standard setting 140 bar.

BC60CFV 12 G /HE B RVPAB/	807734
BC60CFV 24 G /HE B RVPAB/	807735
BC60CFV 12 F /HE B RVPAB/	807736
BC60CFV 24 F /HE B RVPAB/	807737

BC60CFV 12 G /HE B VLAB/	807855
BC60CFV 24 G /HE B VLAB/	807856
BC60CFV 12 F /HE B VLAB/	807857
BC60CFV 24 F /HE B VLAB/	807858

VL valves on ports A and B are type U. Standard setting 140 bar.

BC60CFV 12 G /HE D RVPAB/	807738
BC60CFV 24 G /HE D RVPAB/	807739
BC60CFV 12 F /HE D RVPAB/	807740
BC60CFV 24 F /HE D RVPAB/	807741

BC60CFV 12 G /HE D VLAB/	807859
BC60CFV 24 G /HE D VLAB/	807860
BC60CFV 12 F /HE D VLAB/	807861
BC60CFV 24 F /HE D VLAB/	807862

VL valves on ports A and B are type U. Standard setting 140 bar.

NOTE: After a CF or CVF the first element must be a R type

VERTICAL



RFS HE

2 kg

HORIZONTAL



RFSO HE

2 kg

The pressure compensated flow control section **RFS**, divides the flow in two channels: the priority flow (**PF**) channel, adjustable with the external knob, and the exceeding flow (**EF**) channel that goes to tank. Elements preceding **RFS** sections receive the full pump flow whereas the elements following **RFS** sections receive just the flow requested and settled. In order to prevent undesired heating in the system, the **RFS** section works only when one or more of the following sections are operated. The **RFS** section can be combined with all standard elements.

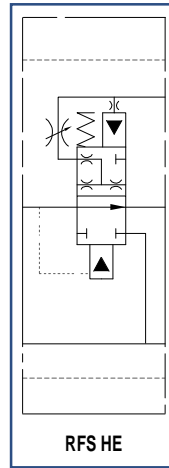

RFS HE

BC60 RFS HE	835011
BC60 RFSO HE	835010

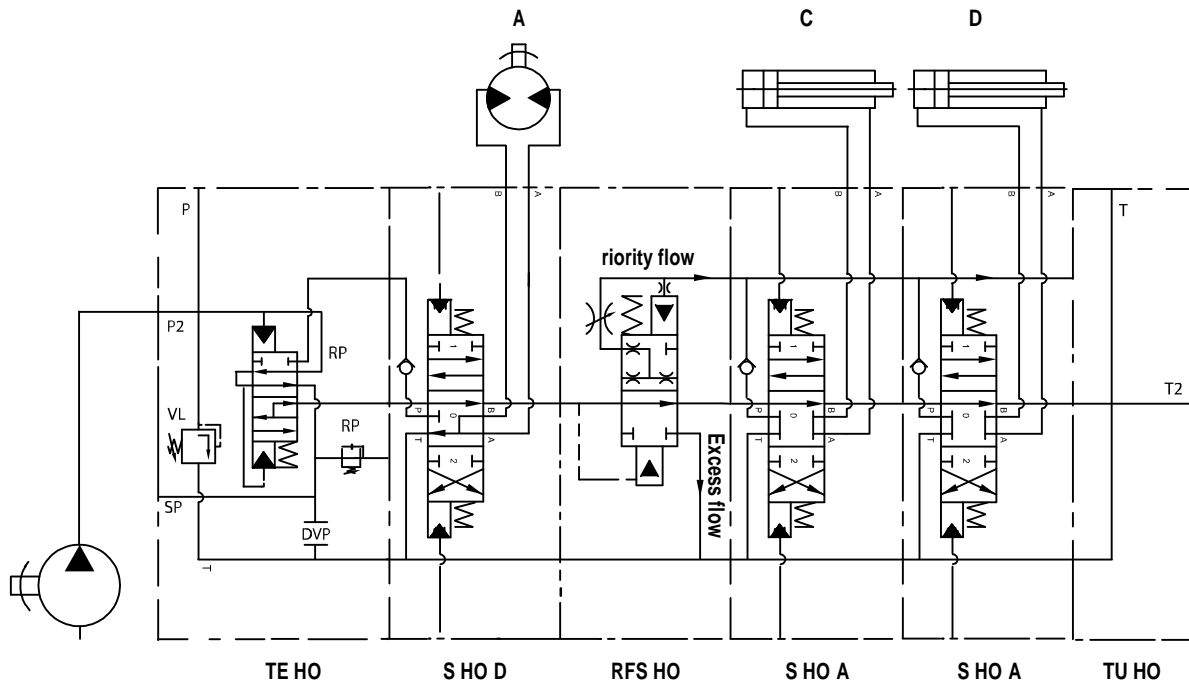

EXAMPLE The motor (A) is fed by the whole flow of the pump. The cylinders (C, D) downstream the flow control element (RFS) are fed only by the priority flow (PF) which is adjustable through the flow control knob on the element. The excess flow goes to tank.

VERTICAL



RFP HE

2 kg

HORIZONTAL



RFPO HE

2 kg

The pressure compensated flow control section **RFP**, divides the flow in two channels: the first channel receives the priority flow (**PF**) (adjustable with the external knob) and feeds one or more Priority elements (**P, PV**); the second channel receives the exceeding flow (**EF**) and feeds one or more Recuperation elements (**R, RV**) which follow the priority ones. **RFP** sections have to be followed by one or more priority elements (**P, PV**) Priority elements have to be followed by one or more Recuperation elements (**R, RV**). In order to prevent undesired heating in the system the **RFP** section works only when one or more of the Priority sections are operated. The installation of an **RFP** section, allows the contemporaneous operation of one Priority element and one Recuperation element which will work at different flows and pressures without interfering one with the other. When no Priority section is operated, the Recuperation elements get the full pump flow.

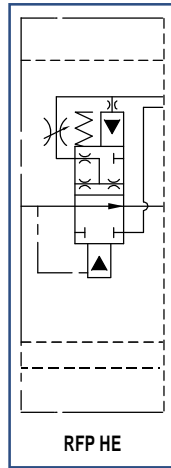

RFP HE

BC60 HE RFP

835121

BC60 HE RFPO

835120

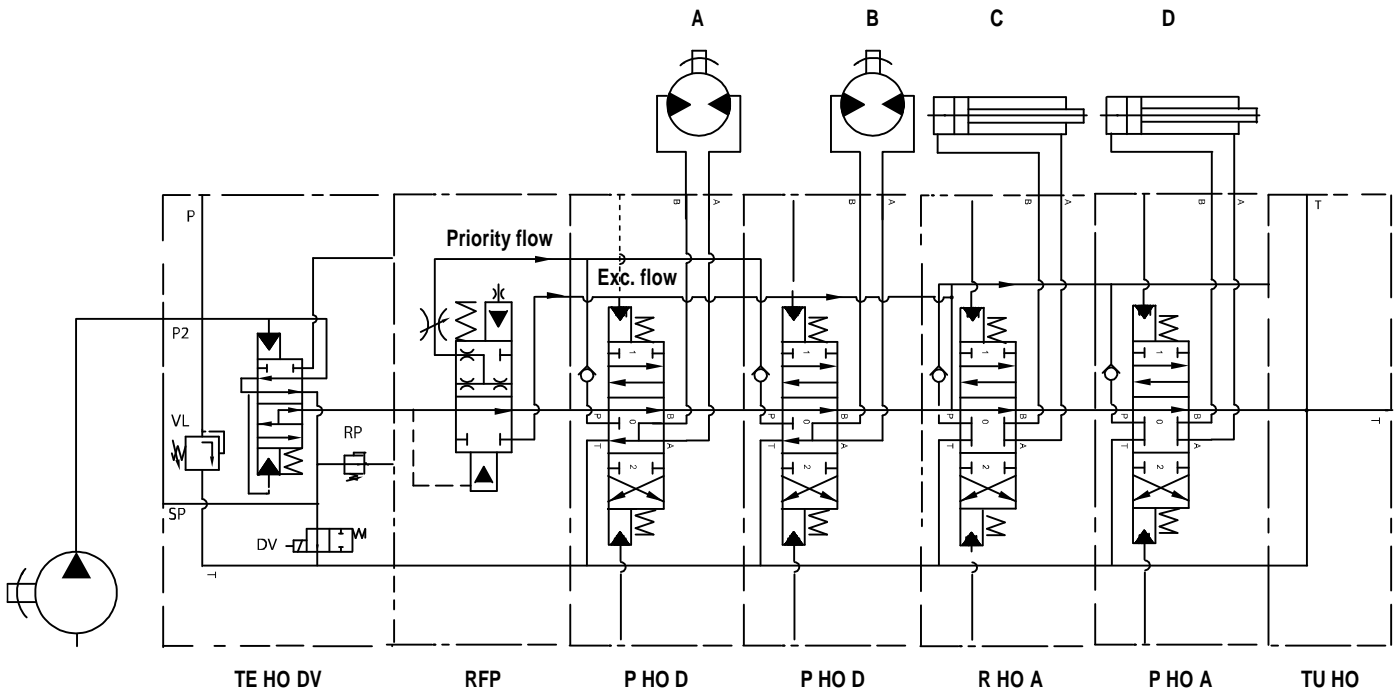

EXAMPLE The motors (A, B) are fed by the priority flow (PF) which is adjustable through the flow control knob on the element. The cylinders (C, D) are fed by the whole flow of the pump when singly actuated. When a cylinder and a motor are simultaneously actuated, the motor is fed by the priority flow (PF) and the cylinder by the exceeding flow (EF). If a cylinder is actuated while a motor is in work, this last will not vary its rotation speed.

PRIORITY ELEMENT

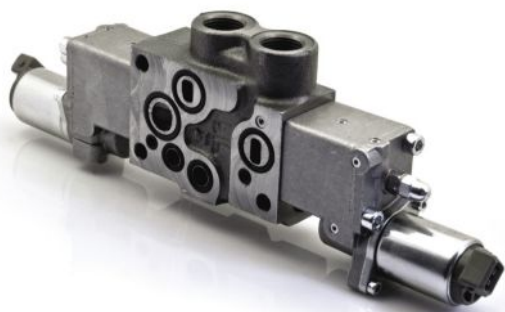

P HE

2,7 kg

PRIORITY ELEMENT
ACCEPTING
VALVES ON
PORTS



PV HE

3,3 kg

P elements use the priority flow regulated by the RFP sections. They have to be installed after an RFP section.

BC60P 12 G /HE A/	807672
BC60P 24 G /HE A/	807673
BC60P 12 F /HE A/	807674
BC60P 24 F /HE A/	807675

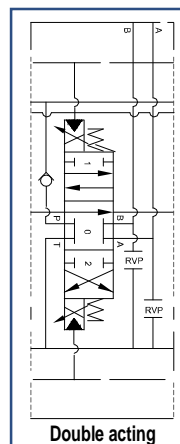
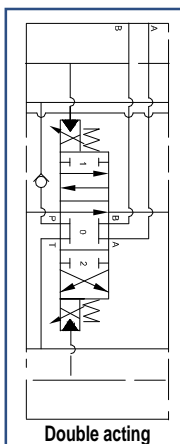

BC60PV 12 G /HE A RVPAB/	807684
BC60PV 24 G /HE A RVPAB/	807685
BC60PV 12 F /HE A RVPAB/	807686
BC60PV 24 F /HE A RVPAB/	807687

BC60PV 12 G /HE A VLAB/	807863
BC60PV 24 G /HE A VLAB/	807864
BC60PV 12 F /HE A VLAB/	807865
BC60PV 24 F /HE A VLAB/	807866

VL valves on ports A and B are type U.
Standard setting 140 bar.

BC60P 12 G /HE B/	807676
BC60P 24 G /HE B/	807677
BC60P 12 F /HE B/	807678
BC60P 24 F /HE B/	807679

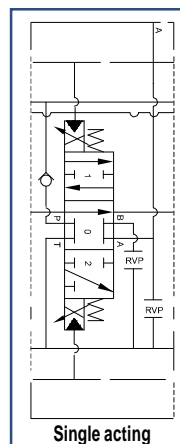
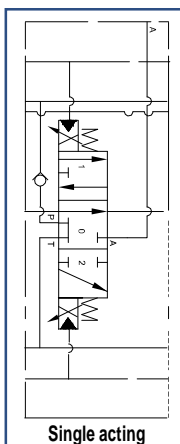

BC60PV 12 G /HE B RVPAB/	807688
BC60PV 24 G /HE B RVPAB/	807689
BC60PV 12 F /HE B RVPAB/	807690
BC60PV 24 F /HE B RVPAB/	807691

BC60PV 12 G /HE B VLAB/	807867
BC60PV 24 G /HE B VLAB/	807868
BC60PV 12 F /HE B VLAB/	807869
BC60PV 24 F /HE B VLAB/	807870

VL valves on ports A and B are type U.
Standard setting 140 bar.

BC60P 12 G /HE D/	807603
BC60P 24 G /HE D/	807681
BC60P 12 F /HE D/	807682
BC60P 24 F /HE D/	807683

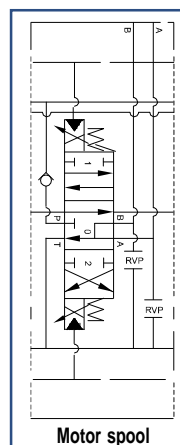
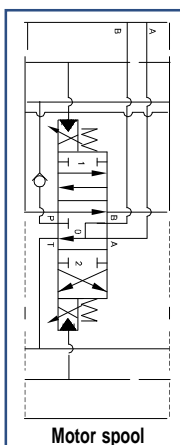

BC60PV 12 G /HE D RVPAB/	807692
BC60PV 24 G /HE D RVPAB/	807693
BC60PV 12 F /HE D RVPAB/	807694
BC60PV 24 F /HE D RVPAB/	807695

BC60PV 12 G /HE D VLAB/	807871
BC60PV 24 G /HE D VLAB/	807872
BC60PV 12 F /HE D VLAB/	807873
BC60PV 24 F /HE D VLAB/	807874

VL valves on ports A and B are type U.
Standard setting 140 bar.

RECUPERATION ELEMENT

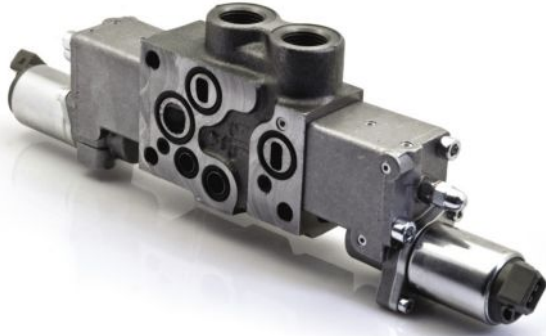

R HE

2,7 kg

RECUPERATION ELEMENT ACCEPTING VALVES ON PORTS

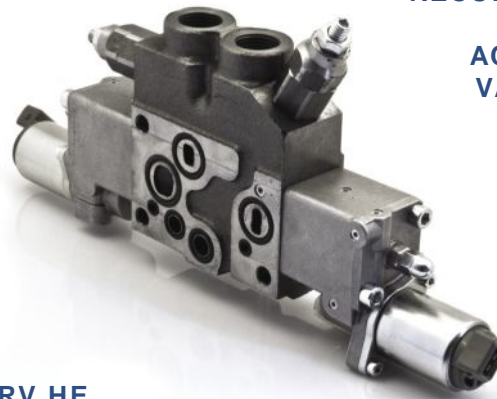

RV HE

3,3 kg

R elements use the exceeding flow coming from an RFP section. They have to be installed only after one or more P elements.

BC60R 12 G /HE A/	807605
BC60R 24 G /HE A/	807680
BC60R 12 F /HE A/	807696
BC60R 24 F /HE A/	807697

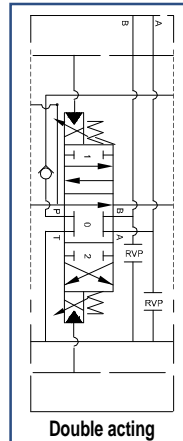
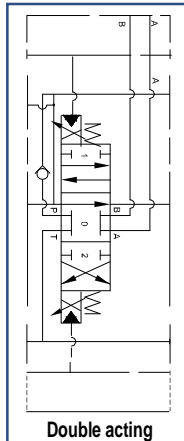

BC60RV 12 G /HE A RVPAB/	807706
BC60RV 24 G /HE A RVPAB/	807707
BC60RV 12 F /HE A RVPAB/	807708
BC60RV 24 F /HE A RVPAB/	807709

BC60RV 12 G /HE A VLAB/	807875
BC60RV 24 G /HE A VLAB/	807876
BC60RV 12 F /HE A VLAB/	807877
BC60RV 24 F /HE A VLAB/	807878

VL valves on ports A and B are type U. Standard setting 140 bar.

BC60R 12 G /HE B/	807698
BC60R 24 G /HE B/	807699
BC60R 12 F /HE B/	807700
BC60R 24 F /HE B/	807701

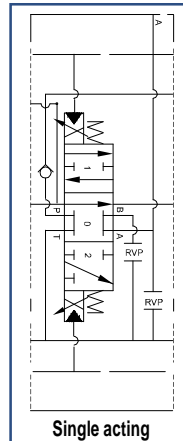
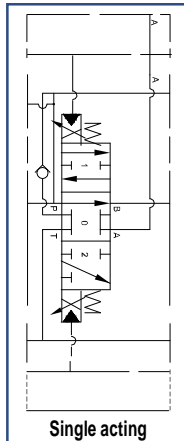

BC60RV 12 G /HE B RVPAB/	807710
BC60RV 24 G /HE B RVPAB/	807711
BC60RV 12 F /HE B RVPAB/	807712
BC60RV 24 F /HE B RVPAB/	807713

BC60RV 12 G /HE B VLAB/	807879
BC60RV 24 G /HE B VLAB/	807880
BC60RV 12 F /HE B VLAB/	807881
BC60RV 24 F /HE B VLAB	807882

VL valves on ports A and B are type U. Standard setting 140 bar.

BC60R 12 G /HE D/	807702
BC60R 24 G /HE D/	807703
BC60R 12 F /HE D/	807704
BC60R 24 F /HE D/	807705

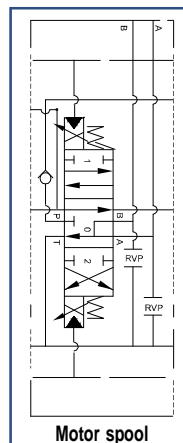
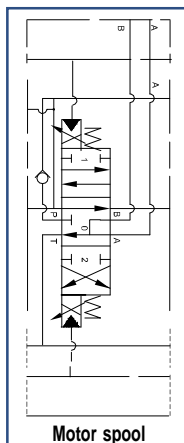

BC60RV 12 G /HE D RVPAB/	807714
BC60RV 24 G /HE D RVPAB/	807715
BC60RV 12 F /HE D RVPAB/	807716
BC60RV 24 F /HE D RVPAB/	807717

BC60RV 12 G /HE D VLAB/	807883
BC60RV 24 G /HE D VLAB/	807884
BC60RV 12 F /HE D VLAB/	807885
BC60RV 24 F /HE D VLAB/	807886

VL valves on ports A and B are type U. Standard setting 140 bar.

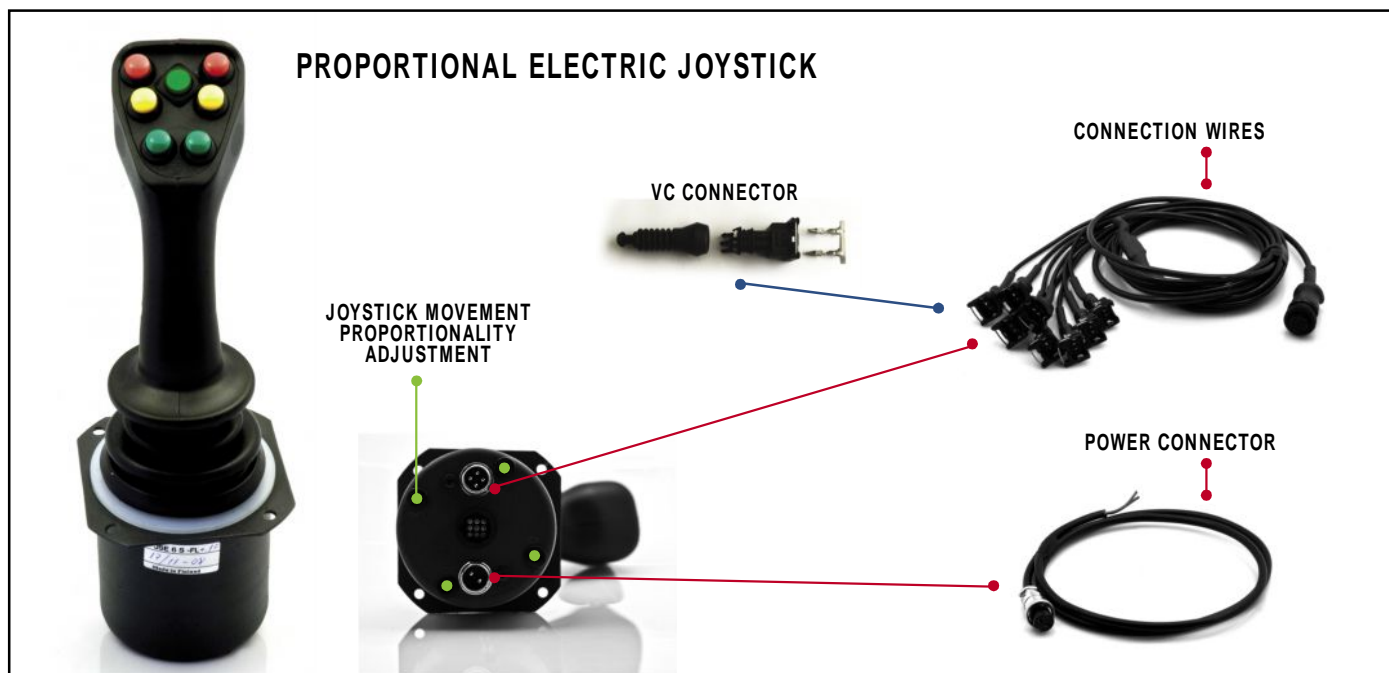

PROPORTIONAL ELECTRIC JOYSTICK



ELECTRIC PROPORTIONAL JOYSTICK WITH 1 AXIS AND MICROSWITCHES

Electric proportional joystick complete with electronic card. Monoaxis version for the control of one proportional element in the BC60 valve. On request, extra microswitches will be available for the operation of further elements (up to 10 switches).

JMPE2S	023081
JMPE4S	023082
JMPE6S	023083
JMPE8S	023084
JMPE10S	023085



ELECTRIC PROPORTIONAL JOYSTICK WITH 2 AXES AND MICROSWITCHES

Electric proportional joystick complete with electronic card. Biaxes version for the control of two proportional elements in the BC60 valve. On request, extra microswitches will be available for the operation of further elements (up to 10 switches).

JSPE2S	023076
JSPE4S	023077
JSPE6S	023078
JSPE8S	023079
JSPE10S	023080

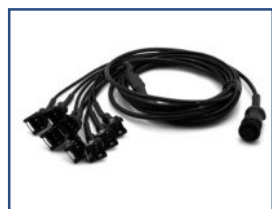

VCC CONNECTION WIRES

Electric wires to connect the joystick to the valve. Standard length 4.50 meters.

VCC E2S	025099
VCC E4S	025100
VCC E6S	025101
VCC E8S	025102
VCC E10S	025103

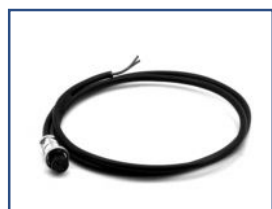

PC POWER CONNECTOR

Connects the joystick to the power source. Standard length 4.50 meters.

PC	025104
----	--------



VC CONNECTOR

Valve connector that allows kinds of wiring different from the usual.

VC	560883
----	--------

INLET



TE HO

2 kg

TE HE inlet elements feature a pressure compensated flow divider and a pressure reducing valve (**RP**) set at 25/30 bar. These two devices are used to generate an auxiliary pressure, needed to operate the spools through electric or hydraulic proportional actuators. The auxiliary pressure can be taken out of the inlet and connected to other users.

BC60TE HO GU	805166
BC60TE HO GK	805008
BC60TE HO FU	805168
BC60TE HO FK	805112

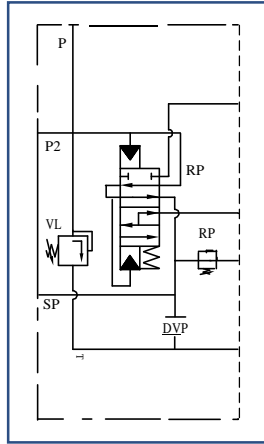

INLET WITH DUMP VALVE



TE HO DV

2,3 kg

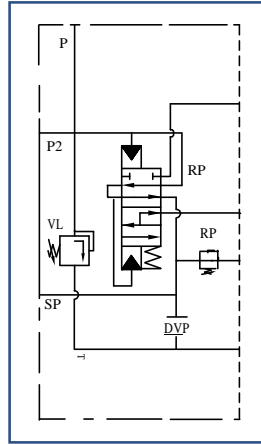

BC60TE 12 HO DV GU	805170
BC60TE 12 HO DV GK	805171
BC60TE 12 HO DV FU	805173
BC60TE 12 HO DV FK	805174
BC60TE 24 HO DV GU	805176
BC60TE 24 HO DV GK	805127
BC60TE 24 HO DV FU	805178
BC60TE 24 HO DV FK	805130

DV dump valve prevents the unwanted or accidental use of the directional control valve, connecting the auxiliary pressure to tank.

OUTLET



TU HO

1,7 kg

BC60TU HO G	805012
BC60TU HO F	805113

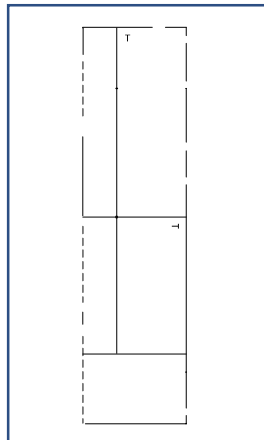

OUTLET WITH VL



TU HO VL

1,9 kg

BC60TU HO VL G	805137
BC60TU HE VL F	805138

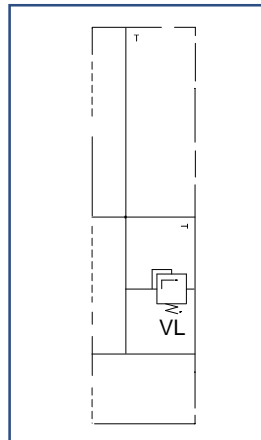

The **VL** valve preserves the system from accidental pressure peaks in the tank line. **VL** setting is 100 bar.

STANDARD ELEMENT



S HO

3,5 kg

STANDARD ELEMENT ACCEPTING VALVES ON PORTS

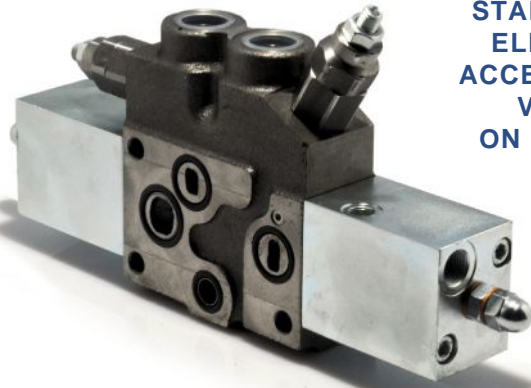

V HO

4,1 kg

BC60S G /HO A/	806279
BC60S F /HO A/	806853

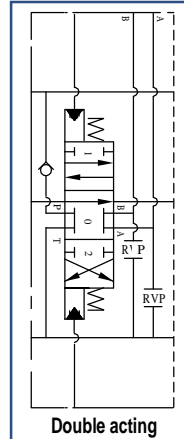
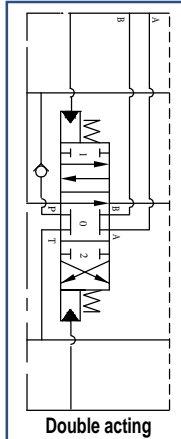

BC60V G /HO A RVPAB/	806803
BC60V F /HO A RVPAB/	806855

BC60V G /HO A/ VLAB/	806887
BC60V F /HO A/ VLAB/	806893

VL valves on ports A and B are type U.
Standard setting 140 bar.

BC60S G /HO B/	806888
BC60S F /HO B/	806891

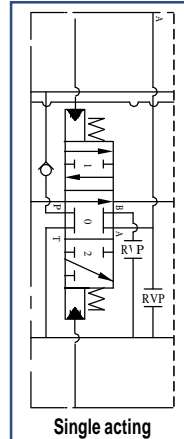
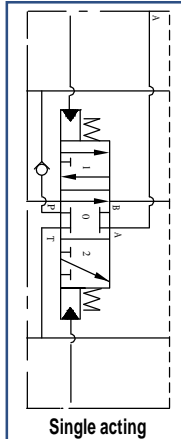

BC60V G /HO B RVPAB/	806894
BC60V F /HO B RVPAB/	806897

BC60V G /HO B VLAB/	806896
BC60V F /HO B VLAB/	806983

VL valves on ports A and B are type U.
Standard setting 140 bar.

BC60S G /HO D/	806889
BC60S F /HO D/	806892

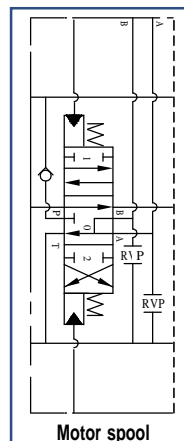
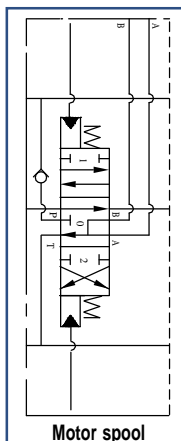

BC60V G /HO D RVPAB/	806895
BC60V F /HO D RVPAB/	806898

BC60V G /HO D VLAB/	806984
BC60V F /HO D VLAB/	806985

VL valves on ports A and B are type U.
Standard setting 140 bar.

FLOW CONTROL ELEMENT

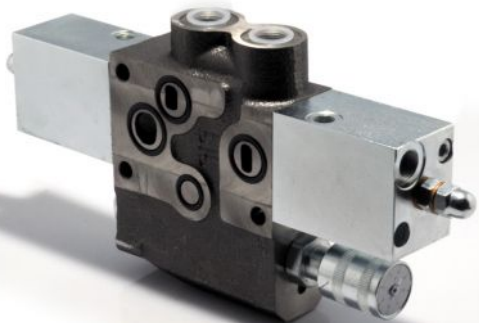

CF HO

4,6 kg

FLOW CONTROL ELEMENT ACCEPTING VALVES ON PORTS

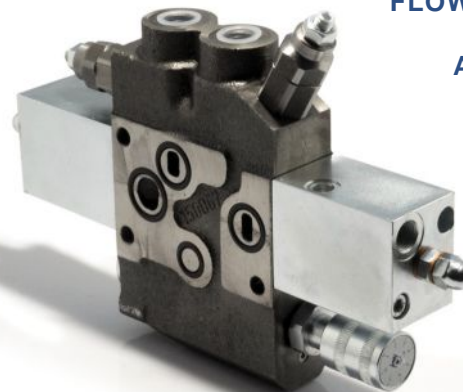

CFV HO

5,2 kg

CF and CFV elements integrate a pressure compensated flow control that allows the external regulation of the flow inside the elements themselves and recuperates the exceeding flow (EF) for the following elements.

BC60CF G /HO A/	806923
BC60CF F /HO A/	806926

BC60CF G /HO B/	806924
BC60CF F /HO B/	806927

BC60CF G /HO D/	806925
BC60CF F /HO D/	806928

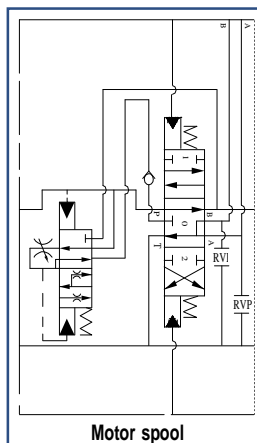
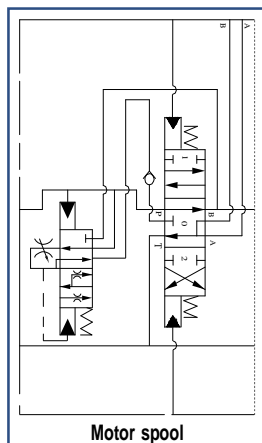
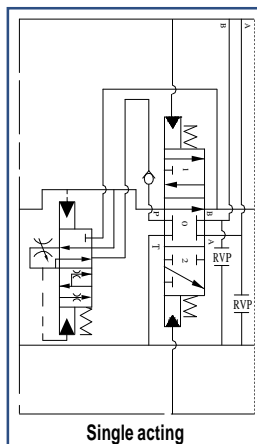
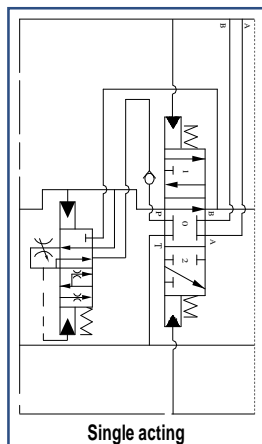
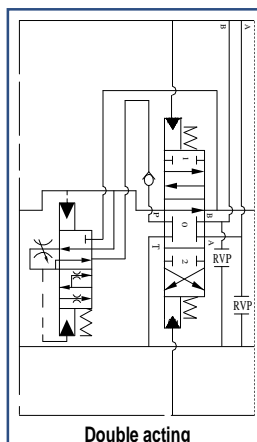
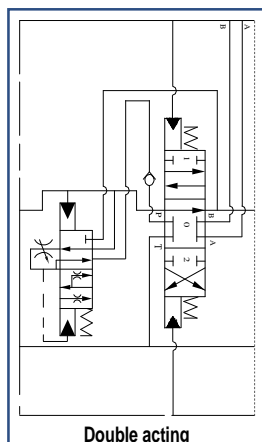

BC60CFV G /HO A RVPAB/	806929
BC60CFV F /HO A RVPAB/	806932

BC60CFV G /HO A VLAB/	809001
BC60CFV F /HO A VLAB/	809002

VL valves on ports A and B are type U. Standard setting 140 bar.

BC60CFV G /HO B RVPAB/	806930
BC60CFV F /HO B RVPAB/	806933

BC60CFV G /HO B VLAB/	809003
BC60CFV F /HO B VLAB/	809004

VL valves on ports A and B are type U. Standard setting 140 bar.

BC60CFV G /HO D RVPAB/	806931
BC60CFV F /HO D RVPAB/	806934

BC60CFV G /HO D VLAB/	809005
BC60CFV F /HO D VLAB/	809006

VL valves on ports A and B are type U. Standard setting 140 bar.

NOTE: After a CF - CVF the first element must be a R type

VERTICAL



RFS HO

2 kg

HORIZONTAL



RFSO HO

2 kg

The pressure compensated flow control section **RFS**, divides the flow in two channels: the priority flow (**PF**) channel, adjustable with the external knob, and the exceeding flow (**EF**) channel that goes to tank. Elements preceding **RFS** sections receive the full pump flow whereas the elements following **RFS** sections receive just the flow requested and settled. In order to prevent undesired heating in the system, the **RFS** section works only when one or more of the following sections are operated. The **RFS** section can be combined with all standard elements.

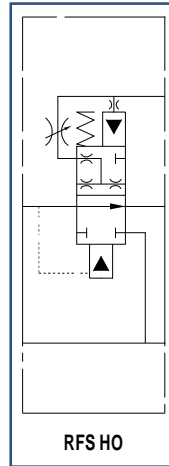

RFS HO

BC60 HO RFS	835001
BC60 HO RFSO	835006

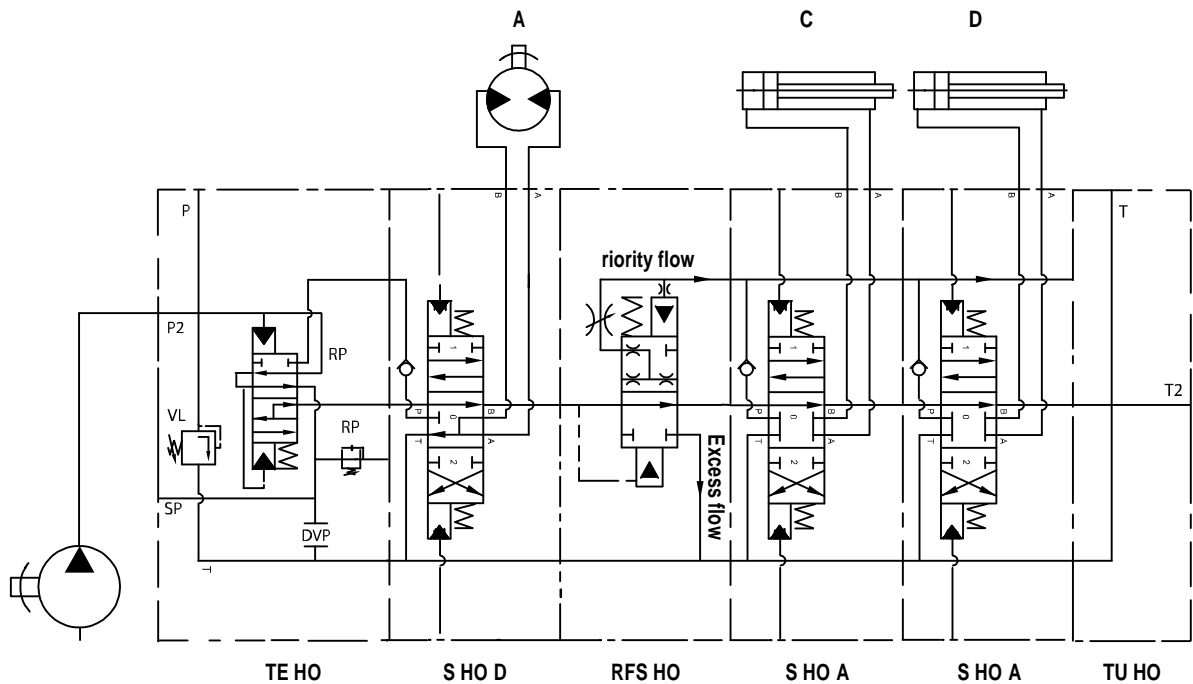

EXAMPLE The motor (A) is fed by the whole flow of the pump. The cylinders (C, D) downstream the flow control element (RFS) are fed only by the priority flow (PF) which is adjustable through the flow control knob on the element. The excess flow goes to the tank.

VERTICAL



RFP HO

2 kg

HORIZONTAL



RFPO HO

2 kg

The pressure compensated flow control section **RFP**, divides the flow in two channels: the first channel receives the priority flow (**PF**) (adjustable with the external knob) and feeds one or more Priority elements (**P**, **PV**); the second channel receives the exceeding flow (**EF**) and feeds one or more Recuperation elements (**R**, **RV**) which follow the priority ones. **RFP** sections have to be followed by one or more priority elements (**P**, **PV**) Priority elements have to be followed by one or more Recuperation elements (**R**, **RV**). In order to prevent undesired heating in the system the **RFP** section works only when one or more of the Priority sections are operated. The installation of an **RFP** section, allows the contemporaneous operation of one Priority element and one Recuperation element which will work at different flows and pressures without interfering one with the other. When no Priority section is operated, the Recuperation elements get the full pump flow.

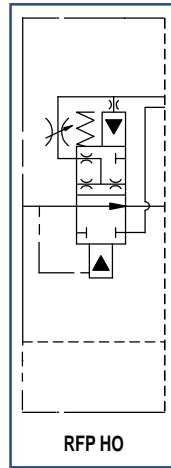

RFP HO

BC60 HO RFP	835004
BC60 HO RFPO	835002

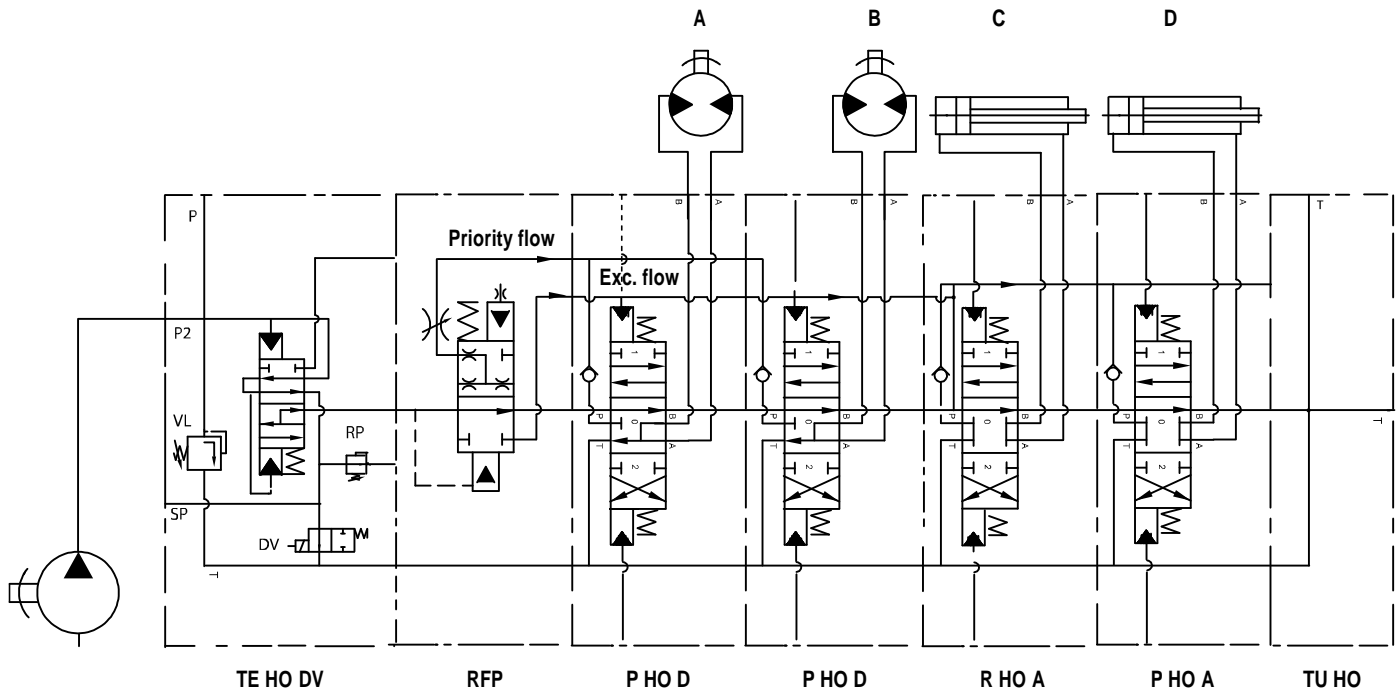

EXAMPLE The motors (A, B) are fed by the priority flow (PF) which is adjustable through the flow control knob on the element. The cylinders (C, D) are fed by the whole flow of the pump when singly actuated. When a cylinder and a motor are simultaneously actuated, the motor is fed by the priority flow (PF) and the cylinder by the exceeding flow (EF). If a cylinder is actuated while a motor is in work, this last will not vary its rotation speed.

PRIORITY ELEMENT

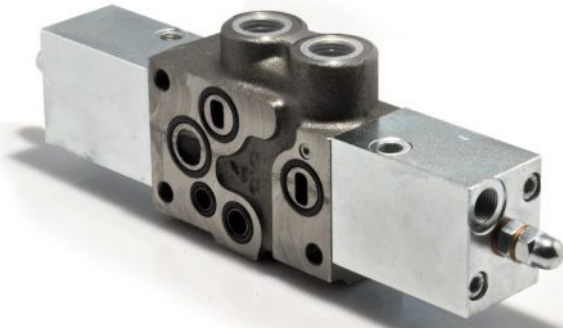

P HO

3,5 kg

PRIORITY ELEMENT ACCEPTING VALVES ON PORTS

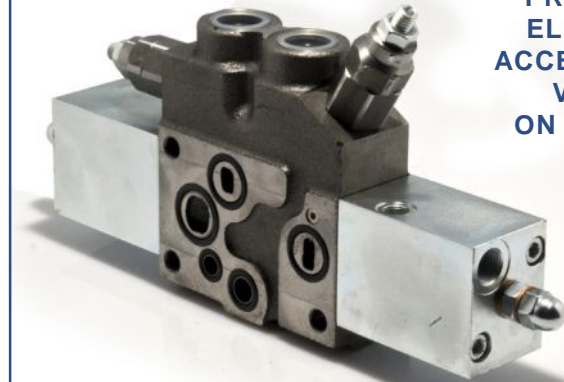

PV HO

4,1 kg

P elements use the priority flow regulated by the RFP sections. They have to be installed after an RFP section.

BC60P G /HO A/	806899
BC60P F /HO A/	806902

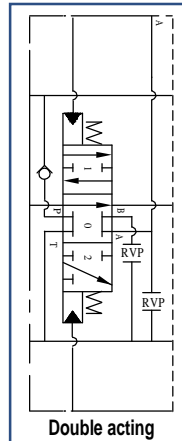
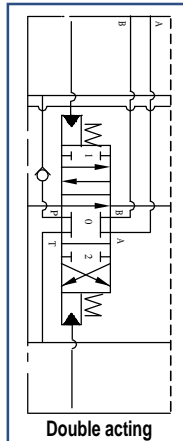

BC60PV G /HO A RVPAB/	806905
BC60PV F /HO A RVPAB/	806908

BC60PV G /HO A VLAB/	806986
BC60PV F /HO A VLAB/	806987

VL valves on ports A and B are type U. Standard setting 140 bar.

BC60P G /HO B/	806900
BC60P F /HO B/	806903

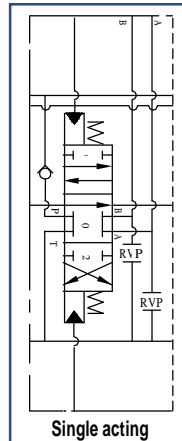
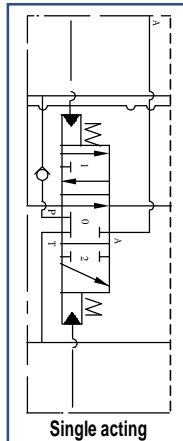

BC60PV G /HO B RVPAB/	806906
BC60PV F /HO B RVPAB/	806909

BC60PV G /HO B VLAB/	806988
BC60PV F /HO B VLAB/	806989

VL valves on ports A and B are type U. Standard setting 140 bar.

BC60P G /HO D/	806901
BC60P F /HO D/	806904

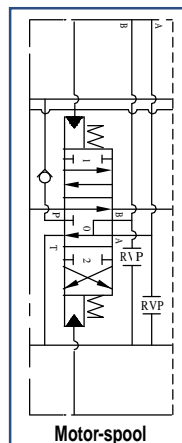
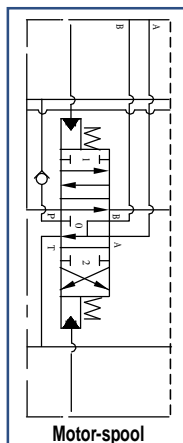

BC60PV G /HO D RVPAB/	806907
BC60PV F /HO D RVPAB/	806910

BC60PV G /HO D VLAB/	806990
BC60PV F /HO D VLAB/	806991

VL valves on ports A and B are type U. Standard setting 140 bar.

RECUPERATION ELEMENT

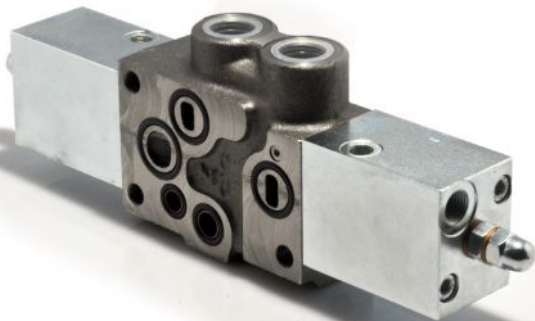

R HO

3,5 kg

R elements use the exceeding flow coming from an RFP section. They have to be installed only after one or more P elements.

BC60R G /HO A/	806911
BC60R F /HO A/	806914

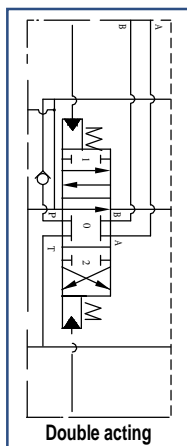

BC60R G /HO B/	806912
BC60R F /HO B/	806915

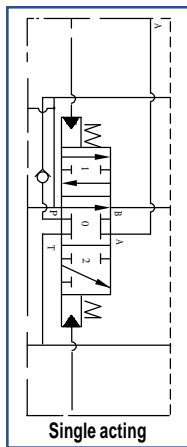

BC60R G /HO D/	COD. 806913
BC60R F /HO D/	COD. 806916

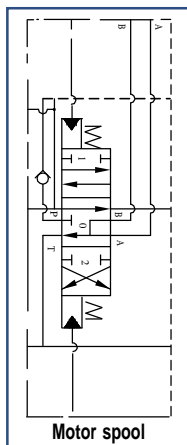

RECUPERATION ELEMENT ACCEPTING VALVES ON PORTS

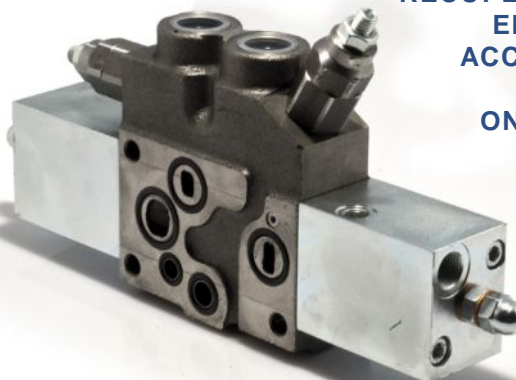

RV HO

4,1 kg

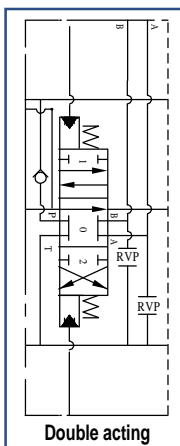

BC60RV G /HO A RVPAB/	806917
BC60RV F /HO A RVPAB/	806920

BC60RV G /HO A VLAB/	806992
BC60RV F /HO A VLAB/	806993

VL valves on ports A and B are type U. Standard setting 140 bar.

BC60RV G /HO B RVPAB/	806918
BC60RV F /HO B RVPAB/	806921

BC60RV G /HO B VLAB/	806994
BC60RV F /HO B VLAB/	806995

VL valves on ports A and B are type U. Standard setting 140 bar.

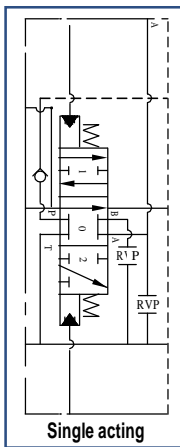

BC60RV G /HO D RVPAB/	806919
BC60RV F /HO D RVPAB/	806922

BC60RV G /HO D VLAB/	806996
BC60RV F /HO D VLAB/	806997

VL valves on ports A and B are type U. Standard setting 140 bar.

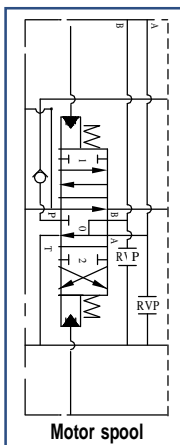

VL INLET RELIEF VALVE Adjustable main relief valve. Allows the external adjustment of the relief valve pressure. The pressure rating is based on a pre-set flow of 8 l/min.

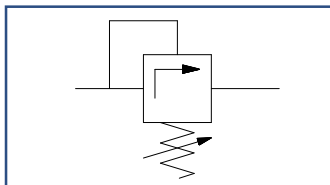

VLU	030916
VLK	030908

RP PRESSURE REDUCING VALVE Reduces the auxiliary pressure to 25/30 bar

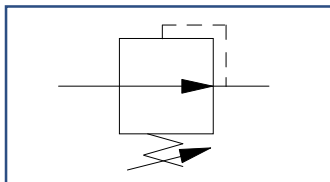

RP	803116
----	--------

TE HE - TE HO COMPENSATOR KIT

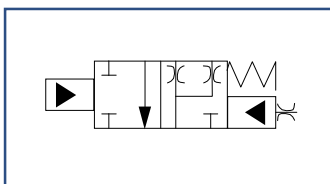

COMPENSATOR	560944
-------------	--------

DV DUMP VALVE prevents the unwanted or accidental use of the directional control valve, connecting the auxiliary pressure to tank.

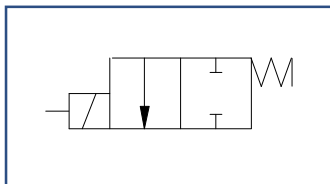

DV 12	025098
DV 24	025094

DVP DUMP VALVES PLUG Replaces the dump valve where not required.

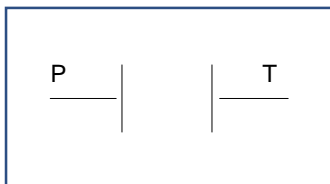

DVP	015024
-----	--------

BRACKETS KIT

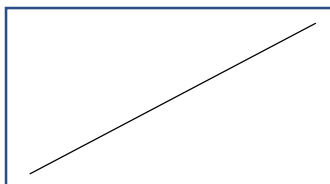

BRACKETS	560893
----------	--------



SPOOL A - AL 4-WAY / 3-POSITION SPOOL. Provides control of double-acting cylinders or bi-directional hydraulic motors. In position 0 work ports are blocked. For a good metering, use spool AL when the flow is lower than 30 l/min.

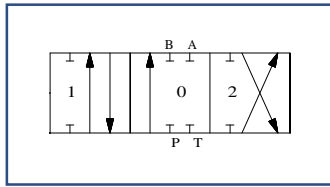

SPOOL A	201088
SPOOL AL	201295

SPOOL B - BL 3-WAY / 3-POSITION SPOOL. Provides control of single-acting cylinders or start and stop of uni-directional hydraulic motors. In position 0 work port is blocked. B port is plugged. For a good metering, use spool BL when the flow is lower than 30 l/min.

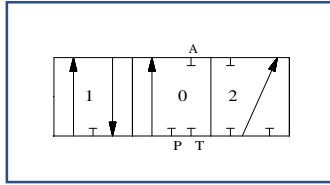

SPOOL B	201089
SPOOL BL	201300

SPOOL D - DL 4-WAY / 3-POSITION SPOOL, OPEN CENTER (MOTOR SPOOL). Provides control of double acting cylinders or bi-directional hydraulic motors. Allows a cylinder to float or a motor to wheel free when the spool is in position 0. Work ports are open to the tank port when the spool is in position 0. For a good metering, use spool DL when the flow is lower than 30 l/min.

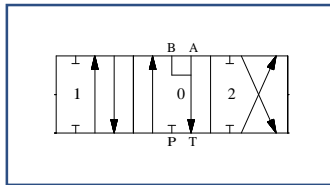

SPOOL D	201090
SPOOL DL	201301

HE ACTUATOR Complete with spool control and proportional pressure reducing valve.

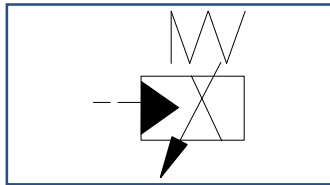

HE 12	801222
HE 24	801223

TM PROPORTIONAL VALVE Pressure reducing electric proportional valve.

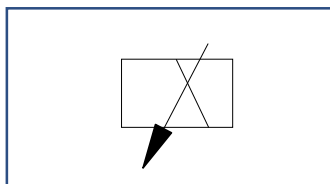

TM 12	025807
TM 24	025808

HO ACTUATOR Complete with spool control

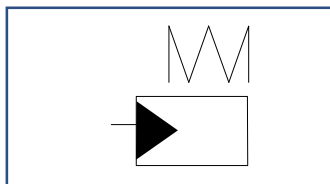

HO	801207
-----------	--------

VL PORTS RELIEF VALVE Adjustable ports relief valve. Allows the external adjustment of the relief valve pressure. The pressure rating is based on a pre-set flow of 8 l/min.

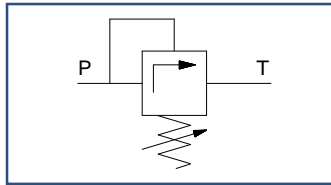

VL X	803060
VL U	803061
VL K	803062

VLC PORTS ANTISHOCK ANTICAVITATION VALVE Combined ports relief and anticavitation valve. Allows the external adjustment of the relief valve pressure. The pressure rating is based on a pre-set flow of 8 l/min.

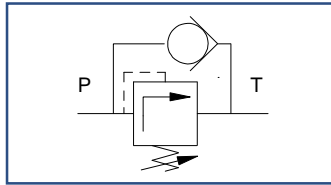

VLC X	803119
VLC U	803083
VLC K	803084

VC PORTS ANTICAVITATION VALVE

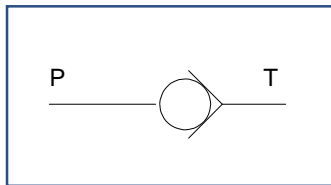

VC	803037
----	--------

RVP RELIEF VALVE PLUG Replaces the relief valve in close center systems where the relief valve is not required.

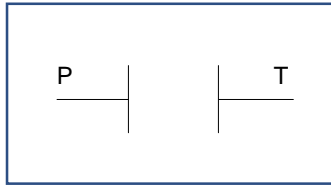

RVP	832010
-----	--------

PB RELIEF VALVE LOCK KIT Prevents users from altering the factory relief valve setting.



PB	560926
----	--------

TIE RODS KIT



BC60/1	560812
BC60/2	560813
BC60/3	560814
BC60/4	560815
BC60/5	560816

BC60/6	560817
BC60/7	560818
BC60/8	560819
BC60/9	560820
BC60/10	560821

HORIZONTAL FLOW CONTROL KIT

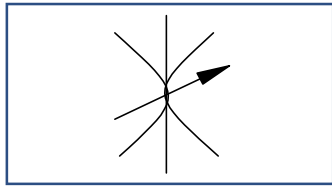

FLOW CONTROL	560475
---------------------	--------



VERTICAL FLOW CONTROL KIT

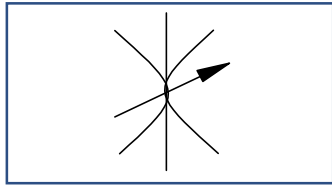

FLOW CONTROL	560437
---------------------	--------

CO CARRY OVER Allows the installation of another valve downstream from the first. To be assembled on T2 port of the valve.

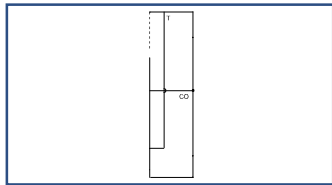

CO G (1/2" BSP)	832004
CO F (7/8"-14 UNF)	832006



CCP CLOSE CENTER PLUG Turns an open center circuit into a close center one.

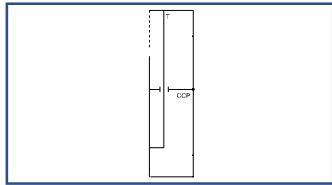

CCP G (1/2" CCP BSP)	832007
CCP F (7/8"-14 UNF)	832008



VL OUTLET RELIEF VALVE High pressure adjustable relief valve. Allows the external adjustment of the relief valve pressure from 80 to 230 bar. The pressure rating is based on a pre-set flow of 8 l/min.

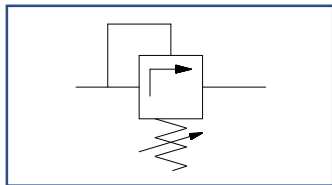

VLU	803034
------------	--------

LSK VALVE Allows the utilization of the BC60 valve in systems with variable displacement pumps (LS)

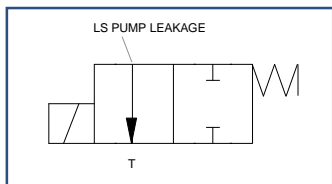

LSK 12 G	030918
LSK 12 F	030920
LSK 24 G	030922
LSK 24 F	030924